

1

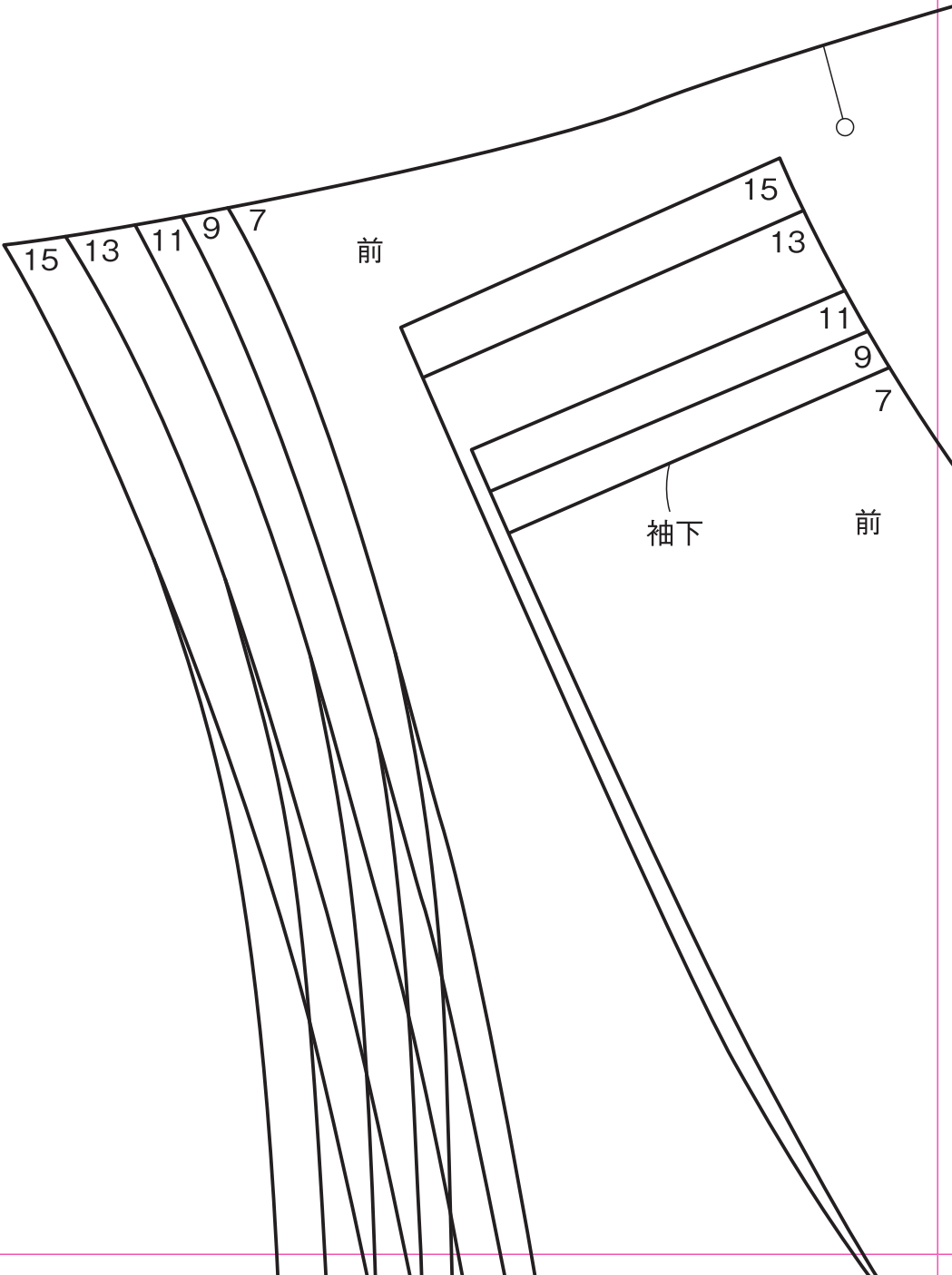

2

ギャザー止まり

肩

14 上えり(丸えり)

6 ギャザー袖



肩

3

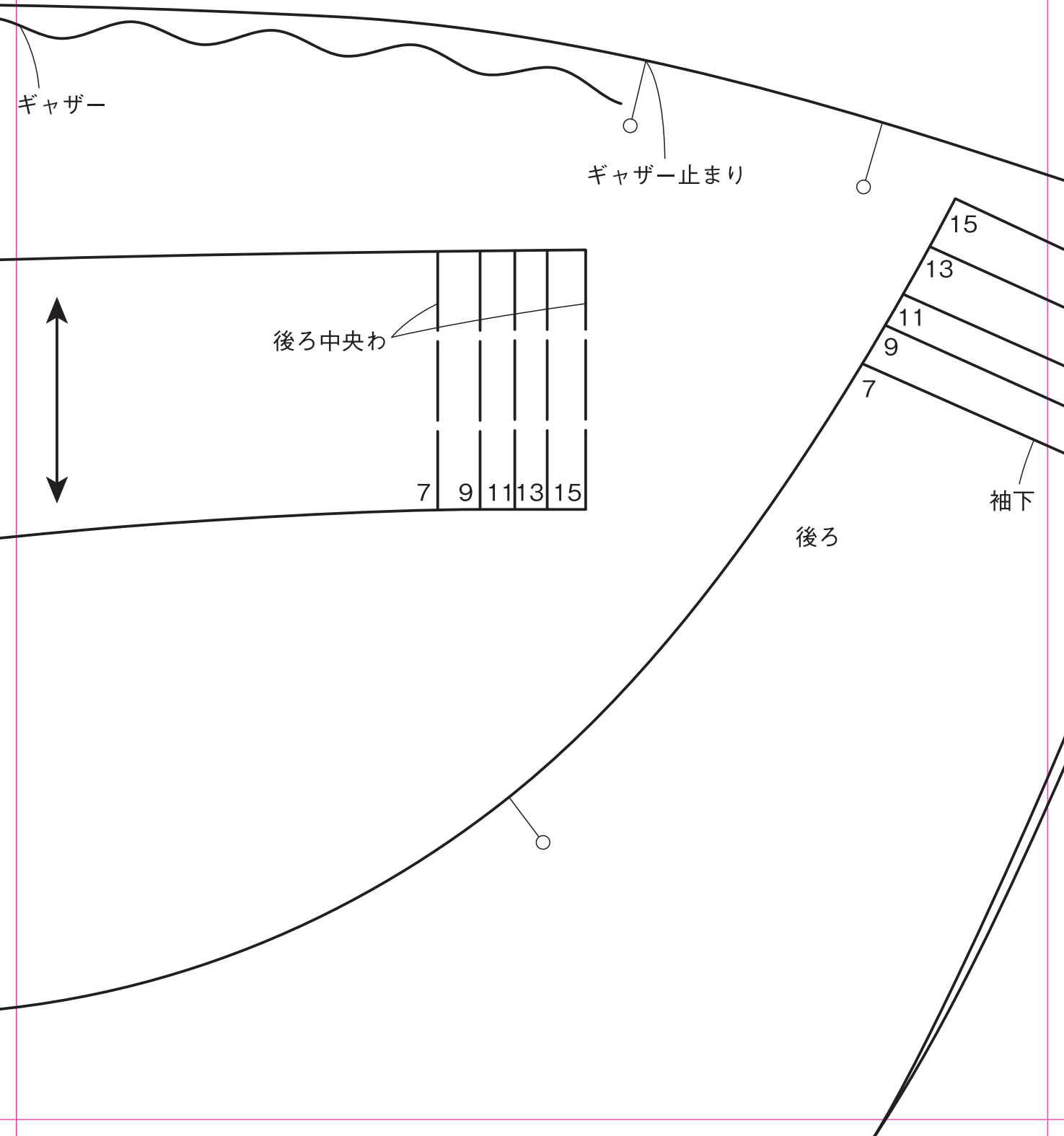

4

実物大型紙

B
面

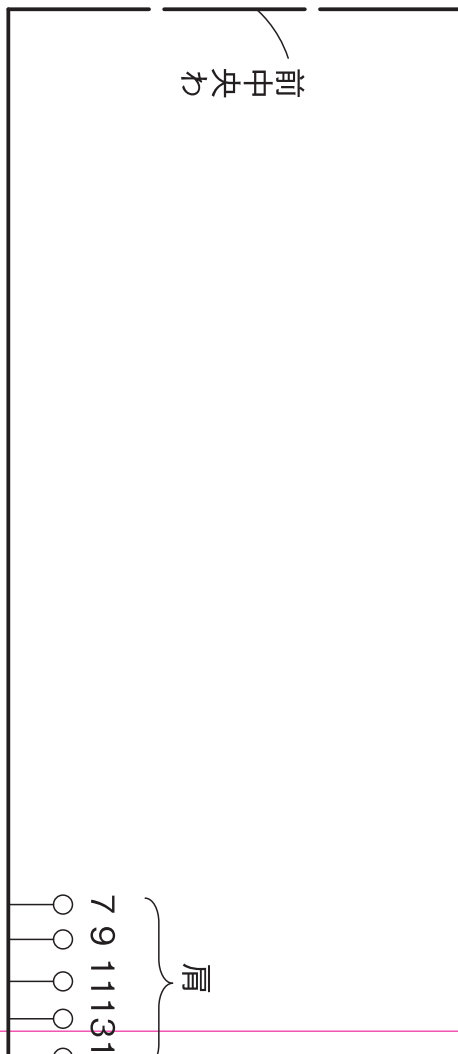
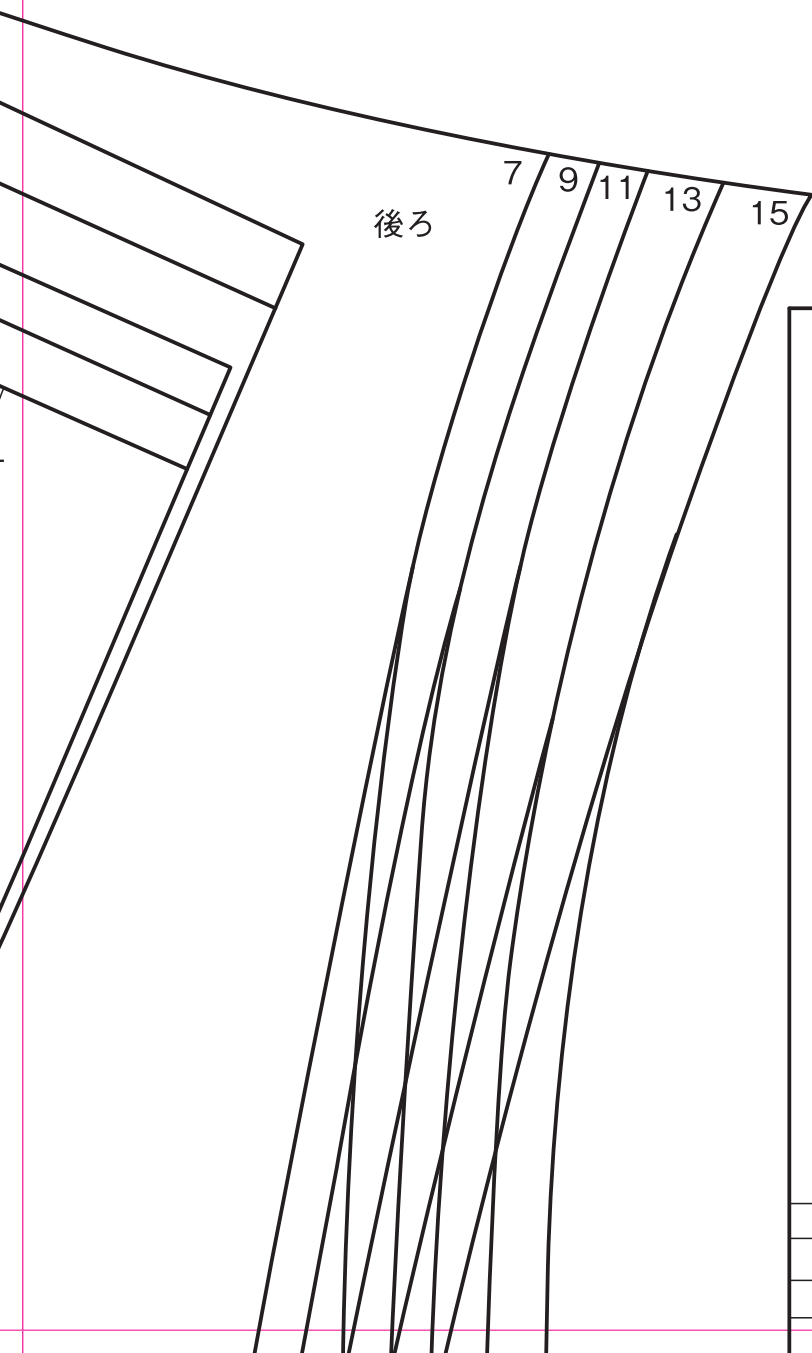

5

袖下B

袖下A

15 13 11 9 7

15
13
11
9
7

B A

左側後ろ端

左側前

15 13 11 9 7

15 13 11 9 7



6

7 フレア袖



15 上えり(角えり)

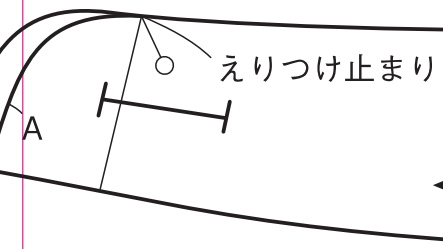

13 台えり

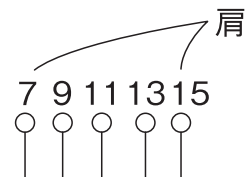

側後ろ中央

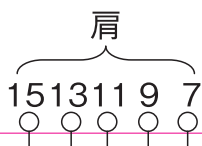

わ

11 スタンドカラー

ギャザー止まり

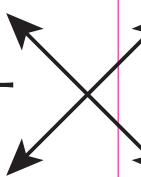

7

袖口 A

後ろ中央わ

7 9 11 13 15

袖口 B

後ろ中央わ

7 9 11 13 15

袖口 C

右側後

肩

7 9 11 13 15

前中央

ギャザー止まり

8

315

7 9 11 13 15

後ろ中央つけ止まり

わ

16 リオ

袖
B

袖
下
A

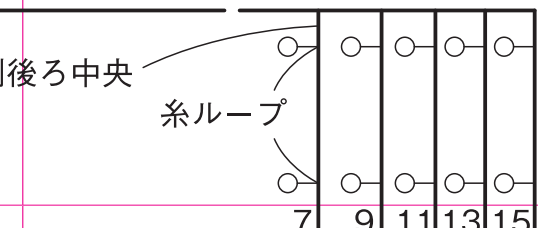
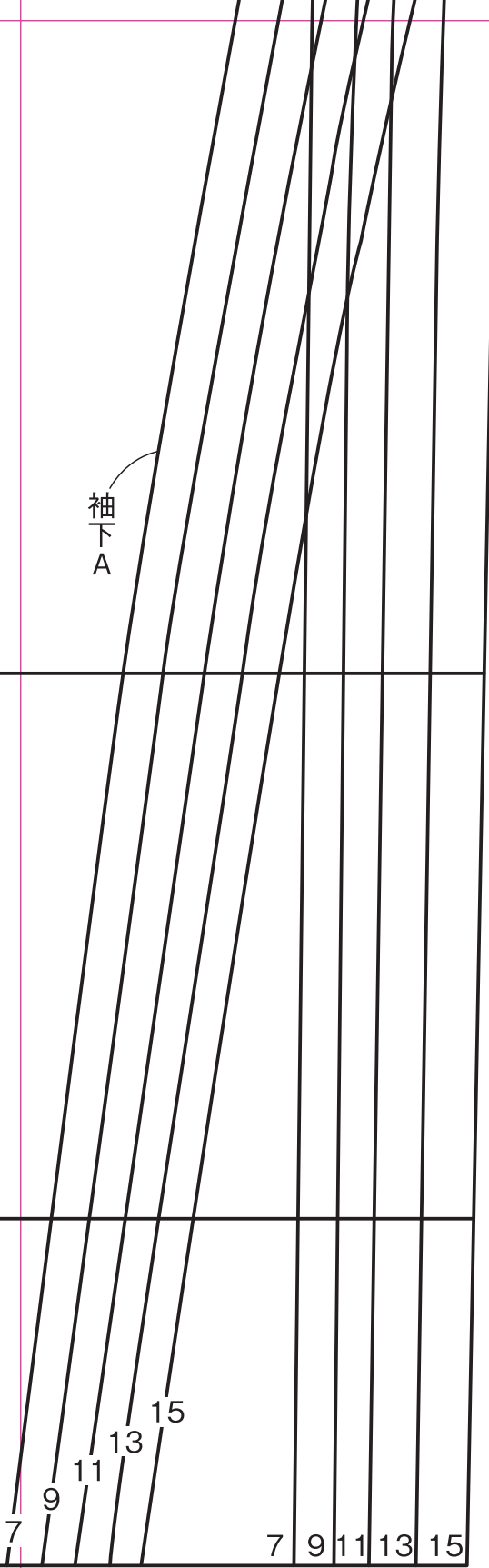

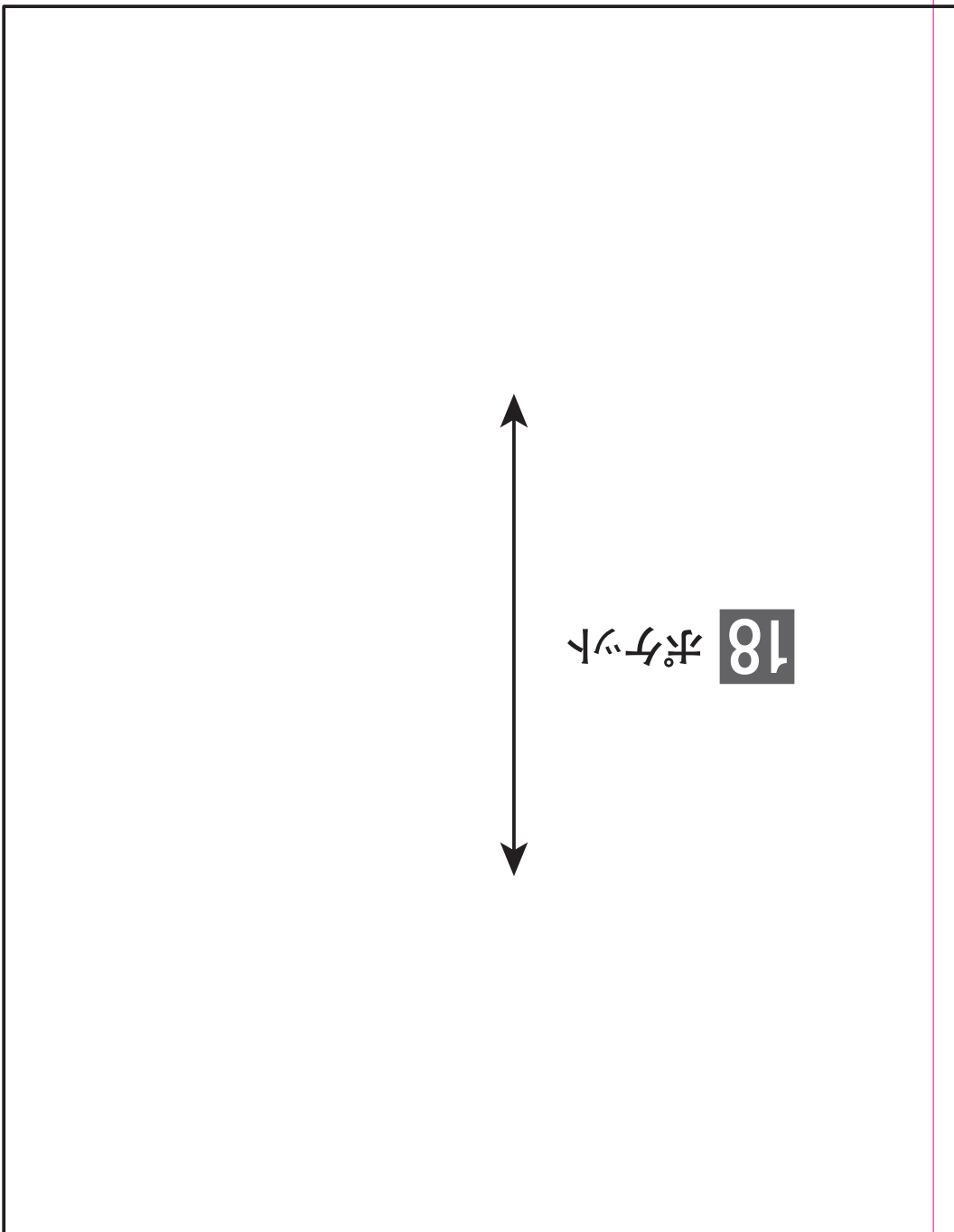

ボケツト 18

9

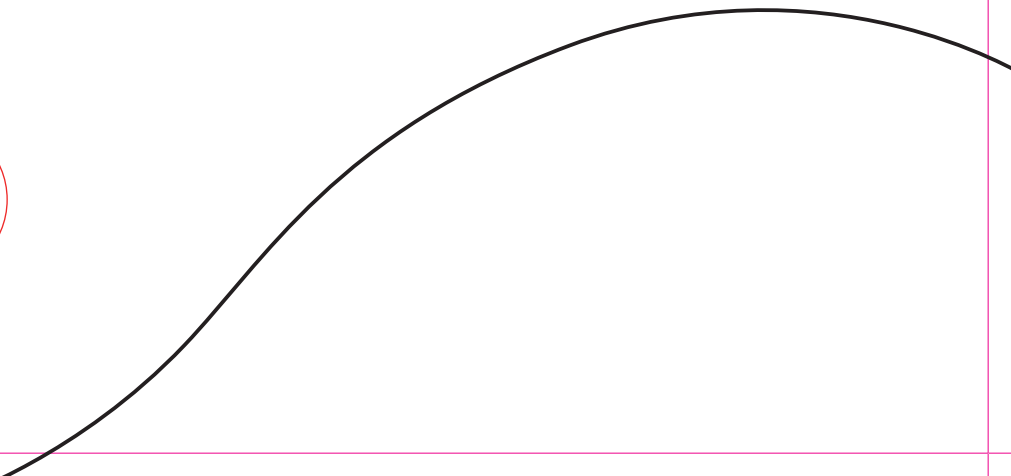

10

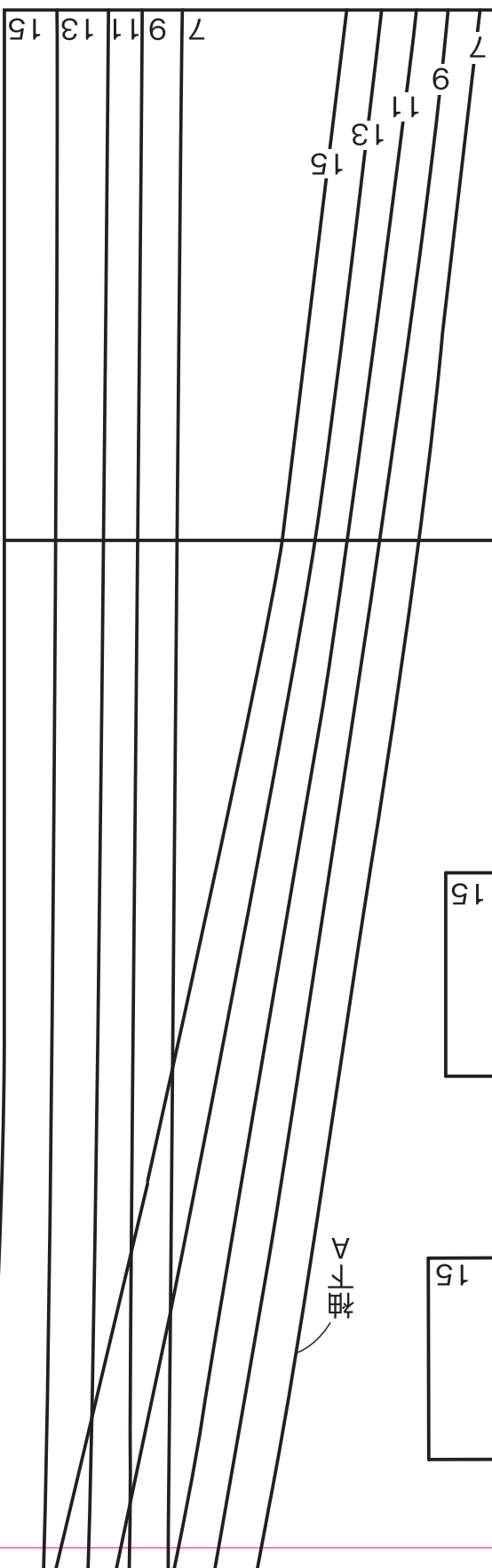

7	9	11	13	15
---	---	----	----	----

7	9	11	13	15
---	---	----	----	----

袖A

袖B

袖口B

袖口A

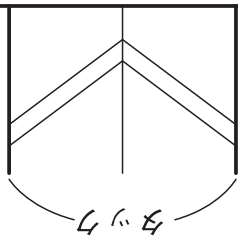

11

わ



6 カラス

わ



8 カラス

ボタンタイ



12

7 9 11 13 15

15 13 11 9 7

15
13
11
9
7

B袖

A袖

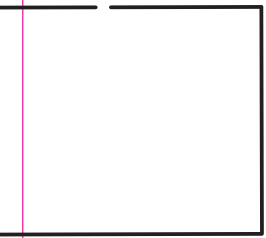
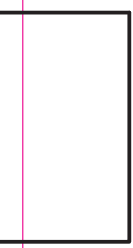

13

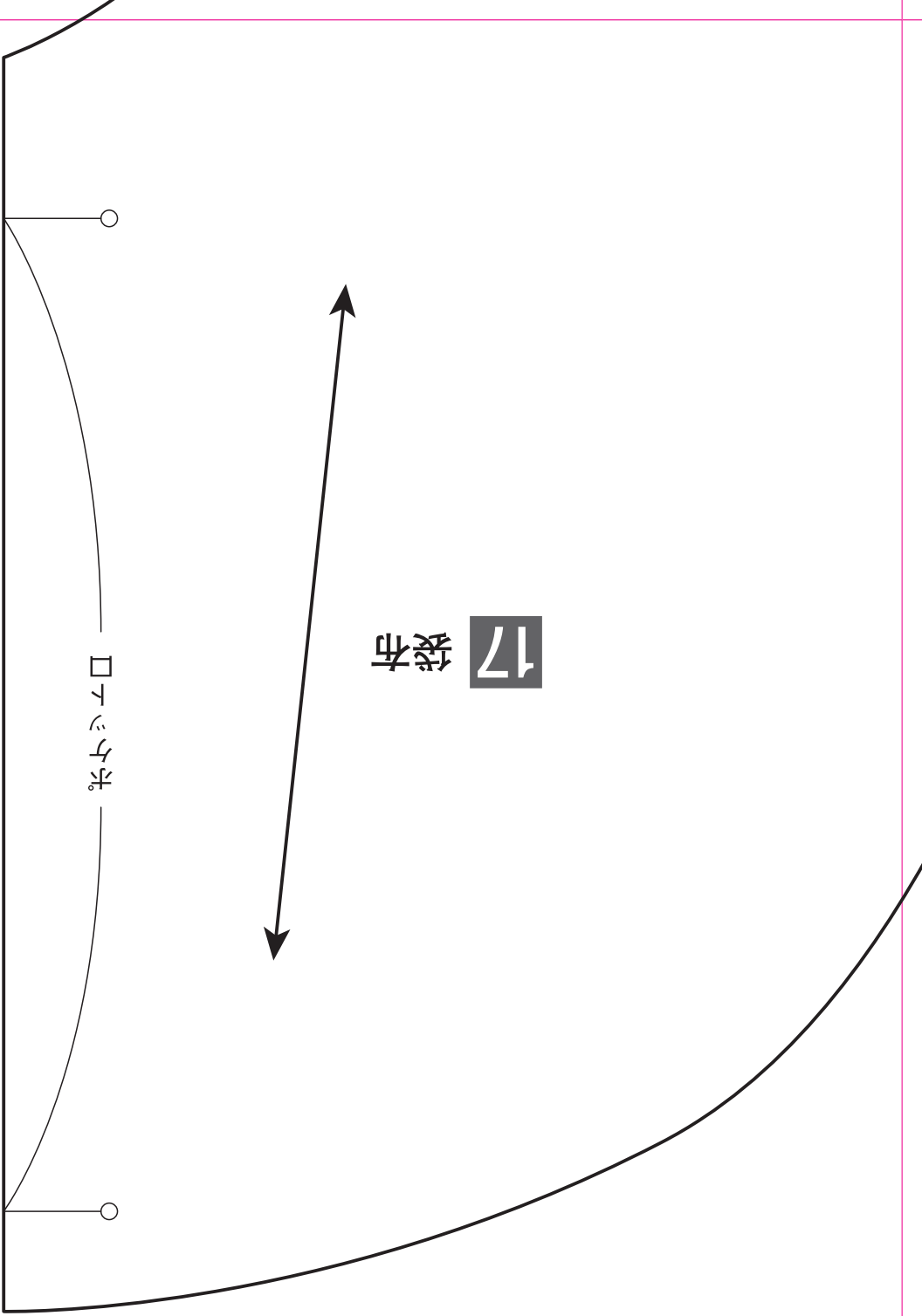
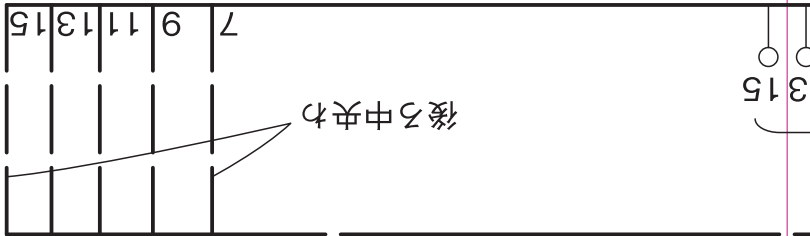

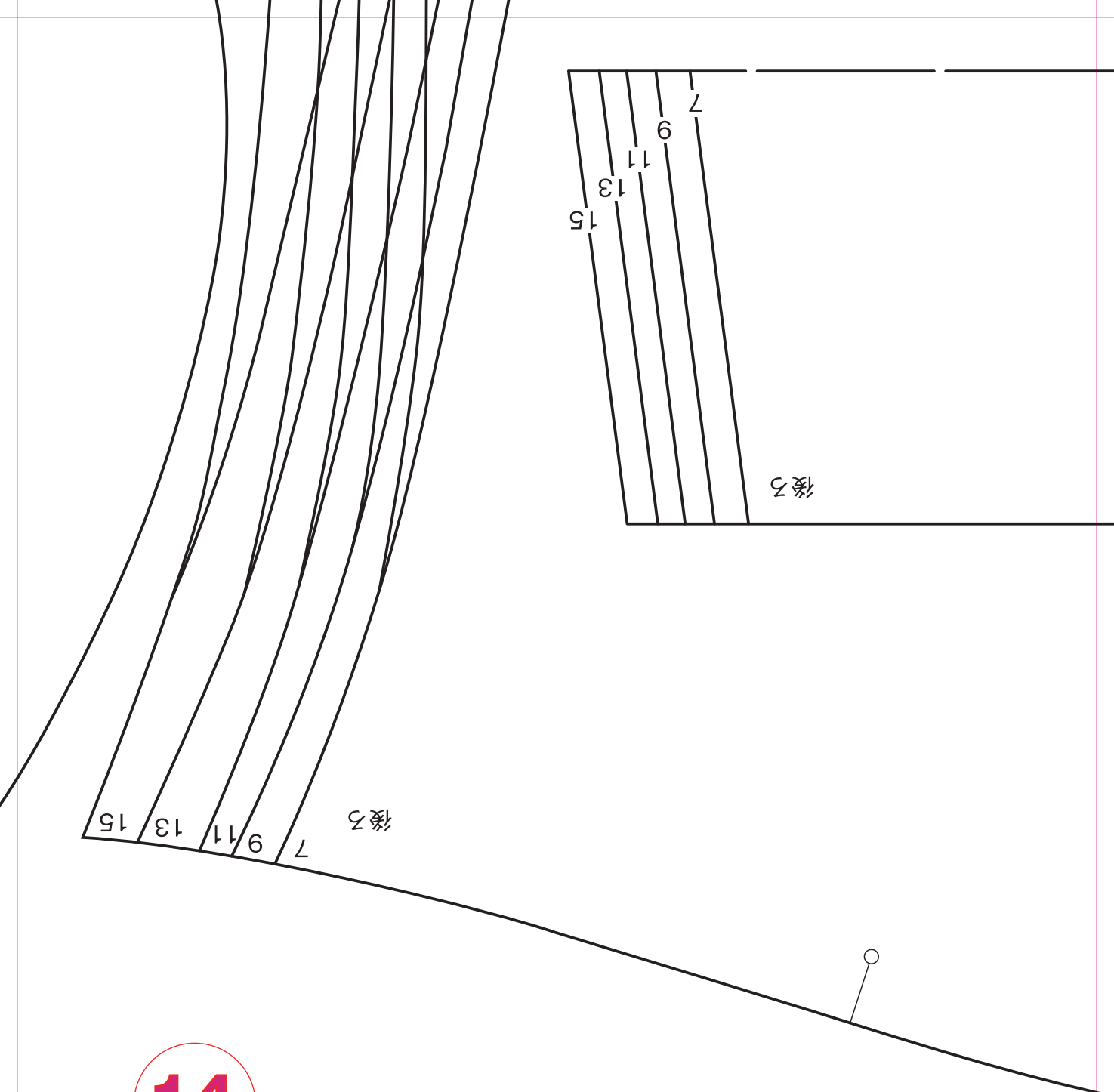

14

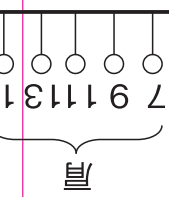

肩止まり



わ



10 カブス

タック位置

15

5 袖



肩



12 ポウタイ

わ

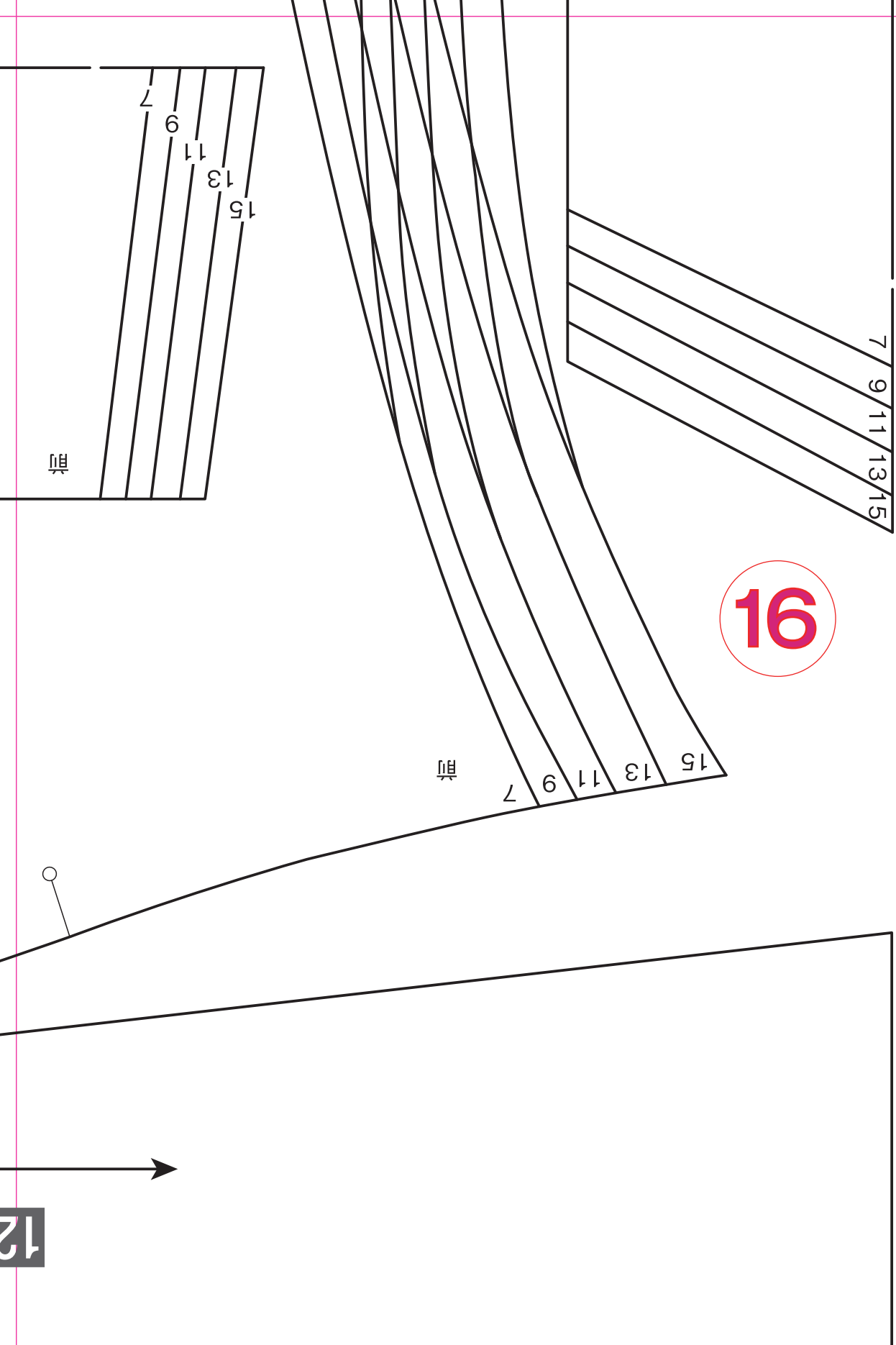

16

12

前

前

7
9
11
13
15

7
9
11
13
15

15
13
11
9
7