

★42 ページ掲載

実物大型紙

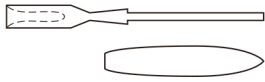

※細いので、少し太めにカットしてあとで調整しながら形を整えると作りやすい。

実物大型紙

<フォーク・大> <スプーン・大> <ねじりスプーン>

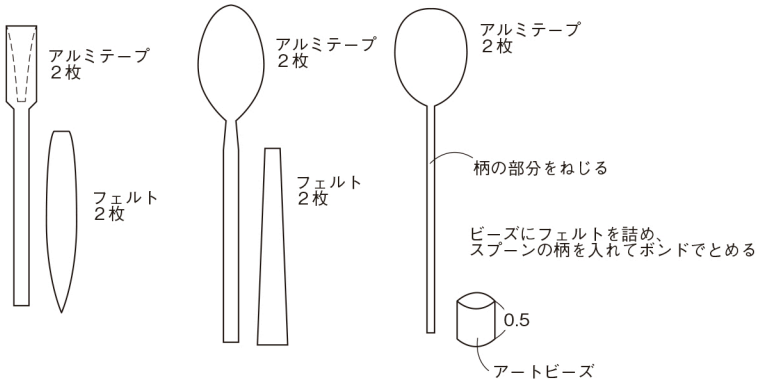

★57 ページ掲載

タッパーB

〈実物大型紙〉

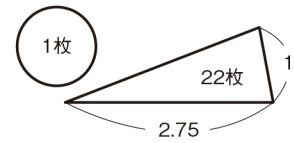

タッパーC

〈実物大型紙〉

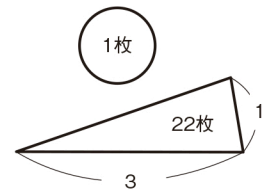

〈実物大型紙〉

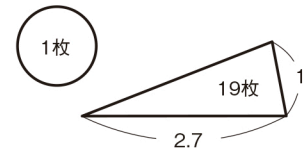

〈実物大型紙〉

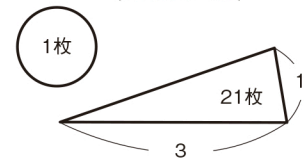

〈実物大型紙〉

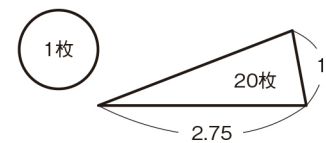

〈実物大型紙〉

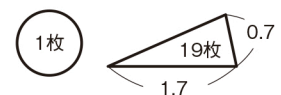

★64 ページ掲載

〈実物大型紙・ラベル〉



★65 ページ掲載

〈実物大型紙・ラベル〉



〈実物大型紙・ラベル〉

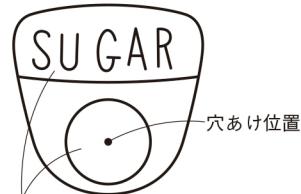

厚紙にホログラムシートを貼り、英字のシールを貼る

〈実物大型紙〉

★69 ページ掲載

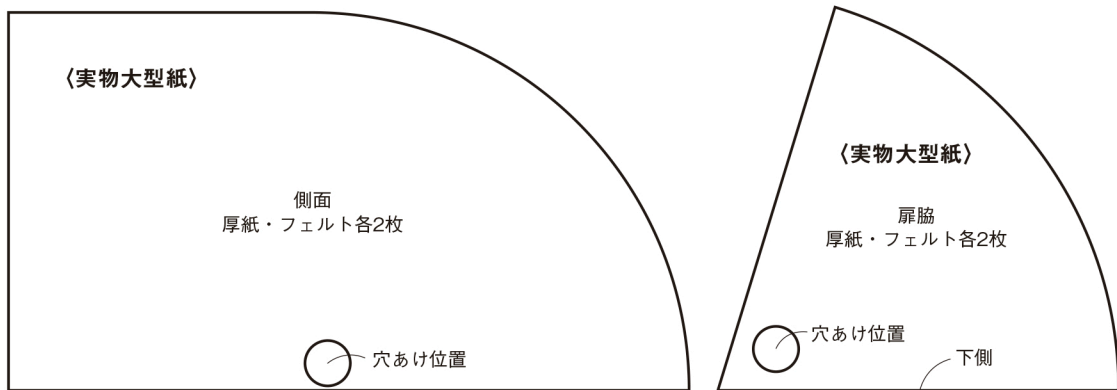

★70 ページ掲載

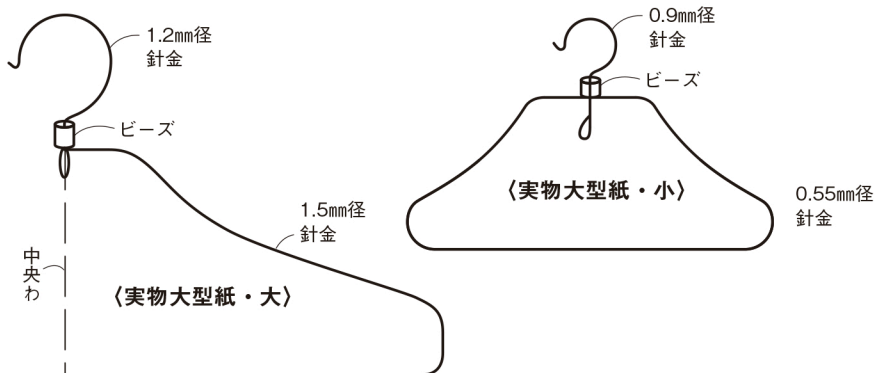

★71 ページ掲載

★73 ページ掲載

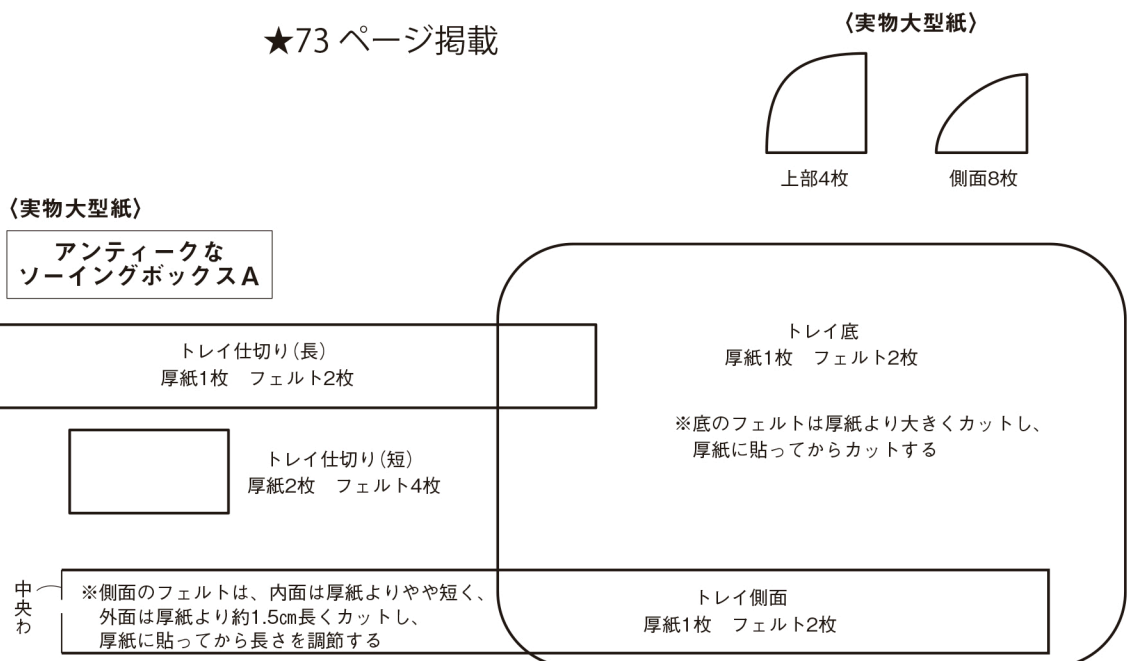

★60 ページ掲載

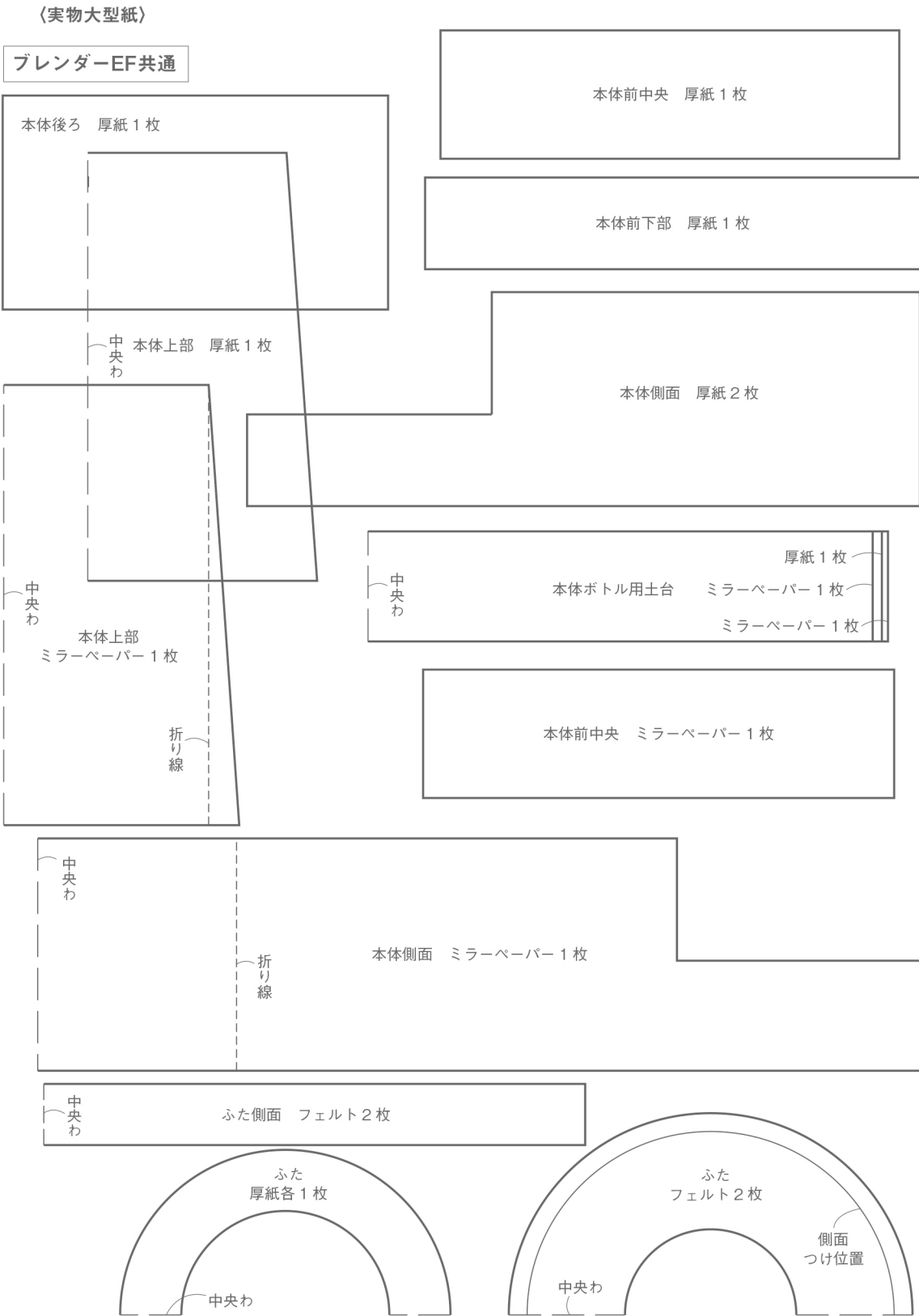

★61 ページ掲載

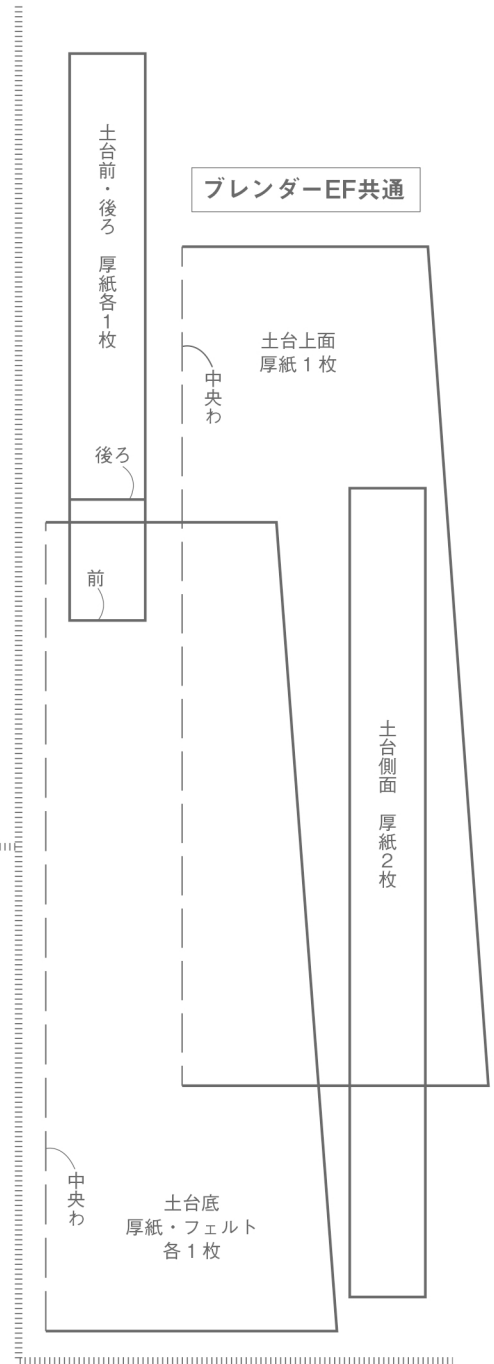
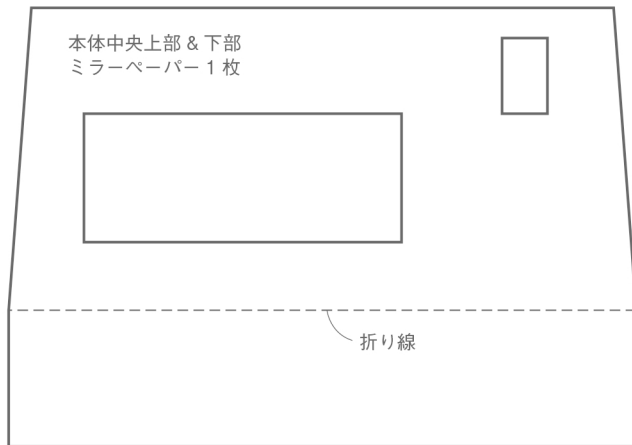
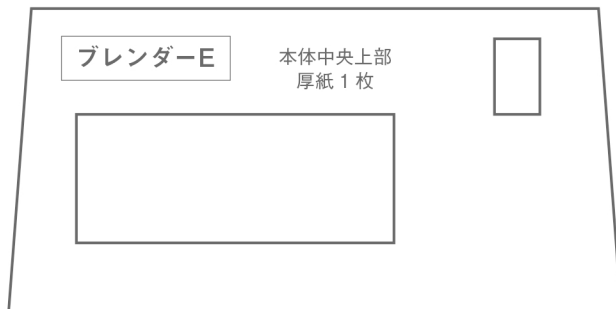
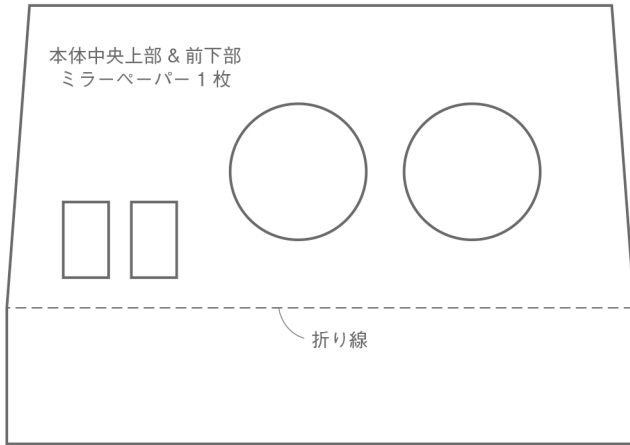
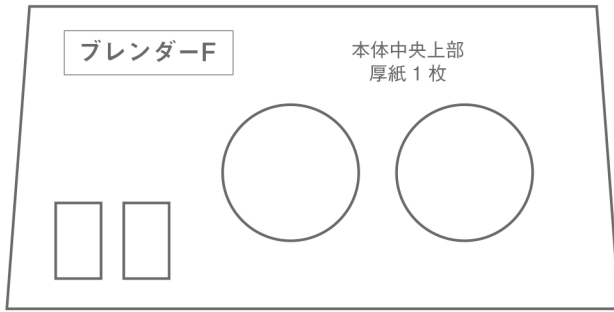

ボタン(4個分)



厚紙 4 枚
フェルト(赤)5枚
フェルト(クリーム色)15枚

ボタン(1個分)



厚紙 1 枚
フェルト(黒)5枚

★63 ページ掲載

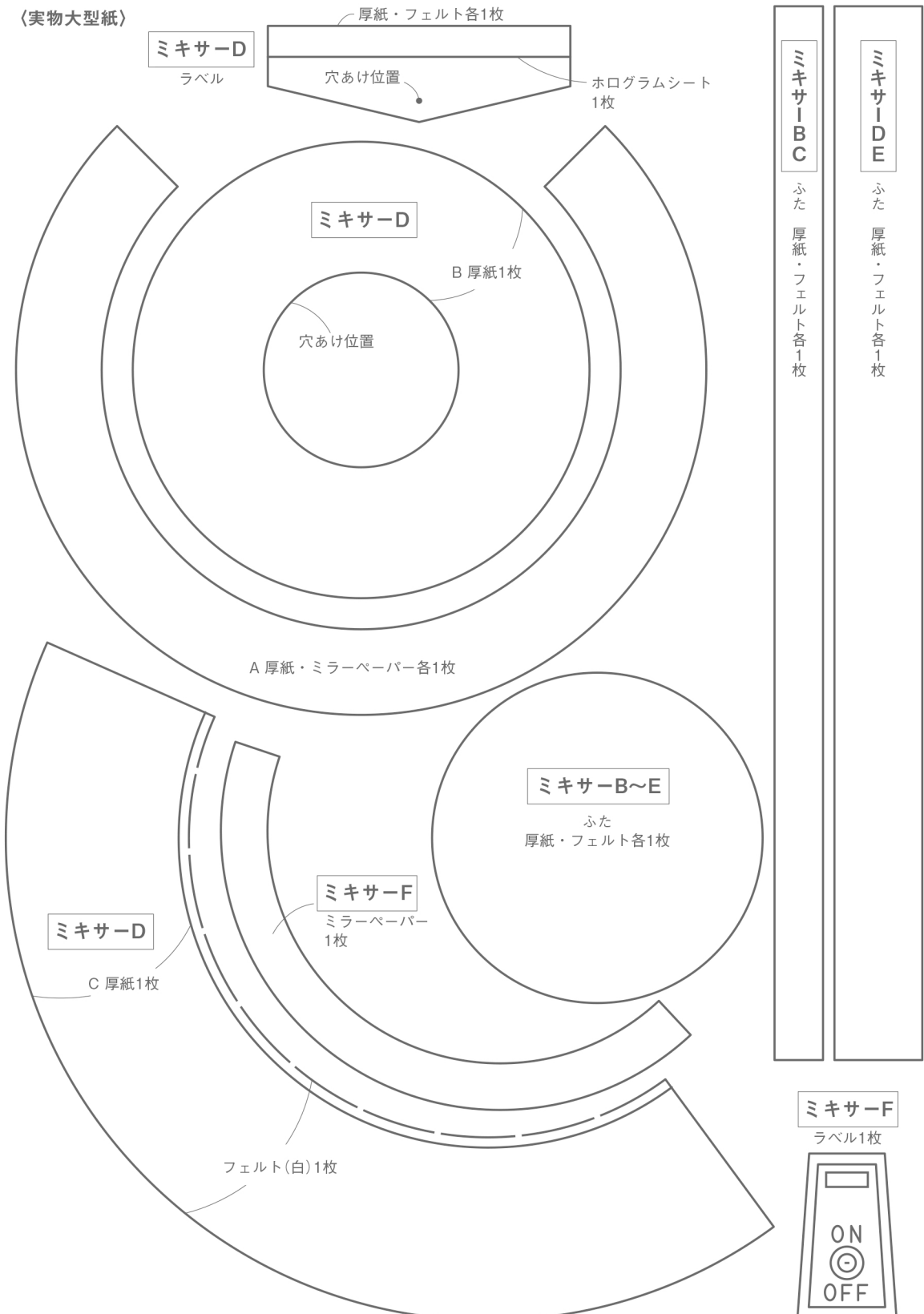

★74 ページ掲載

〈実物大型紙〉

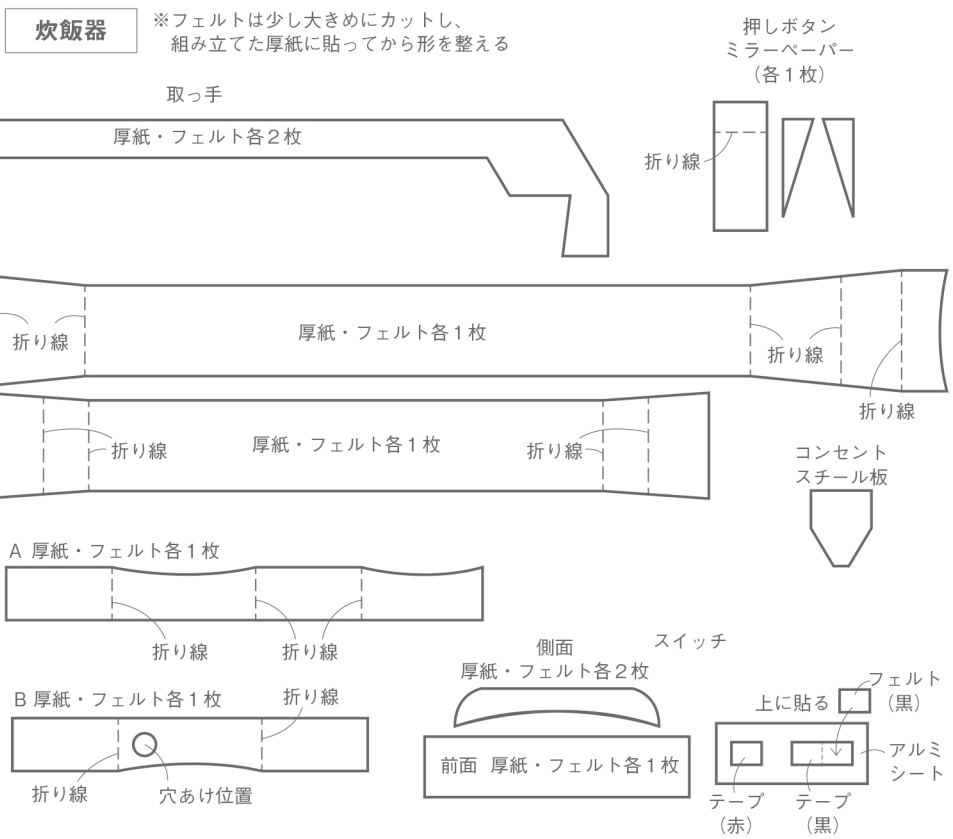

〈実物大型紙〉

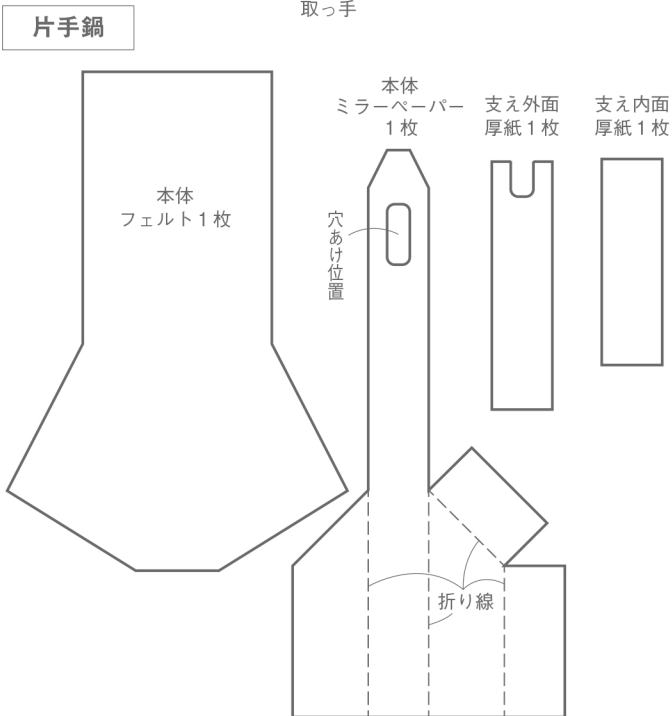

〈実物大型紙〉

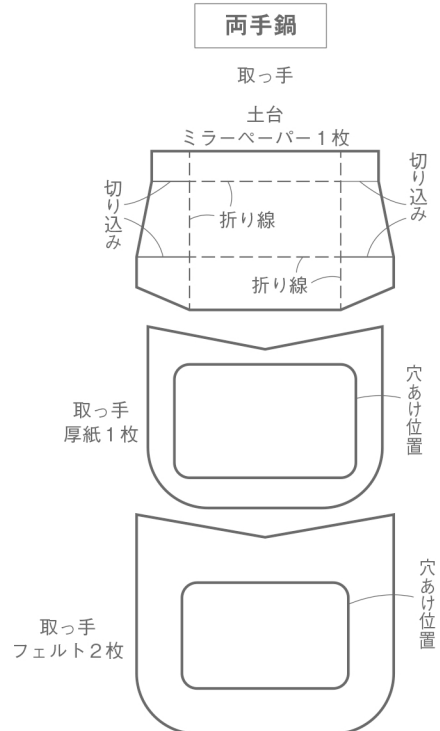

★75 ページ掲載

〈実物大型紙〉

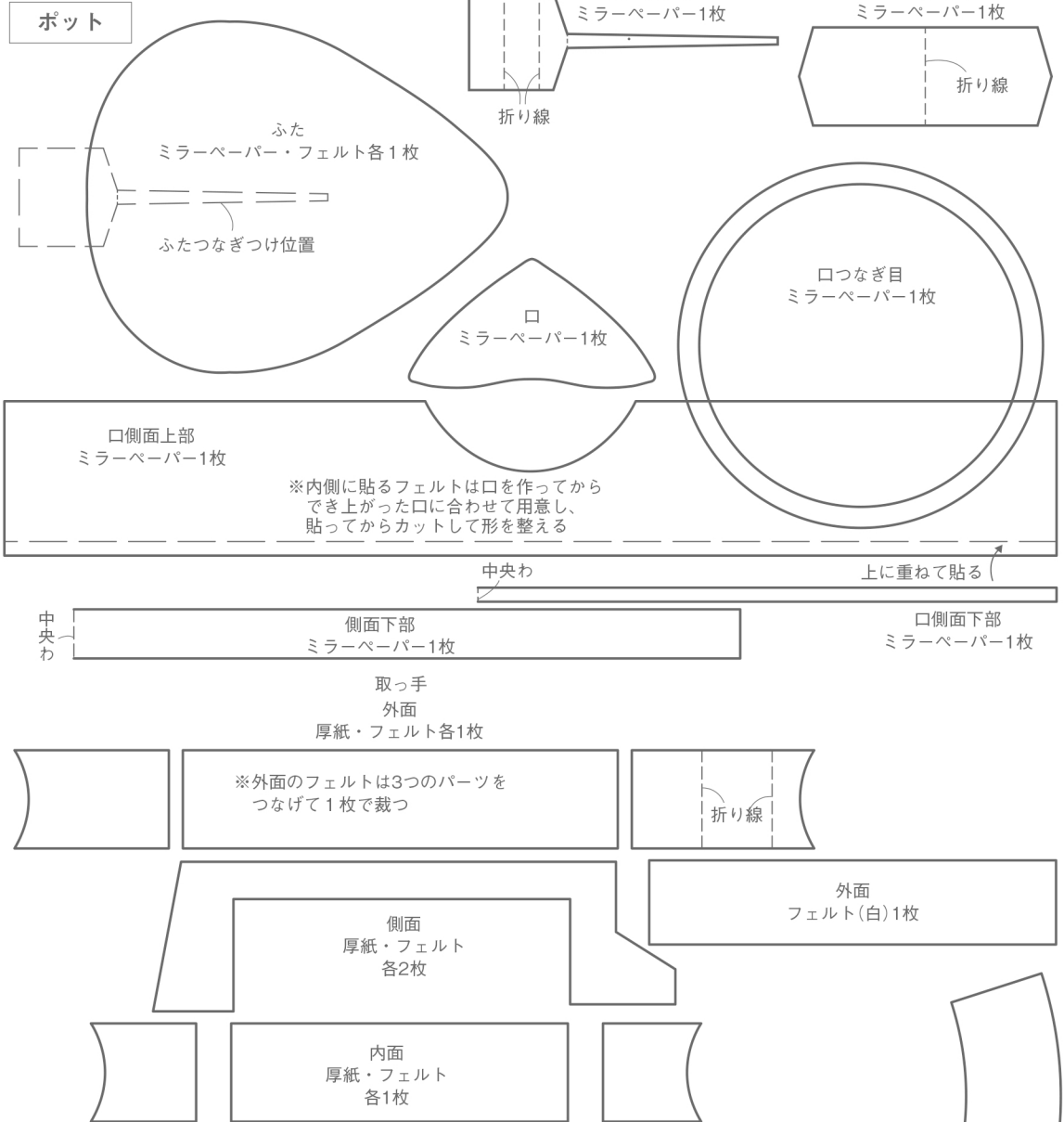

〈実物大型紙〉

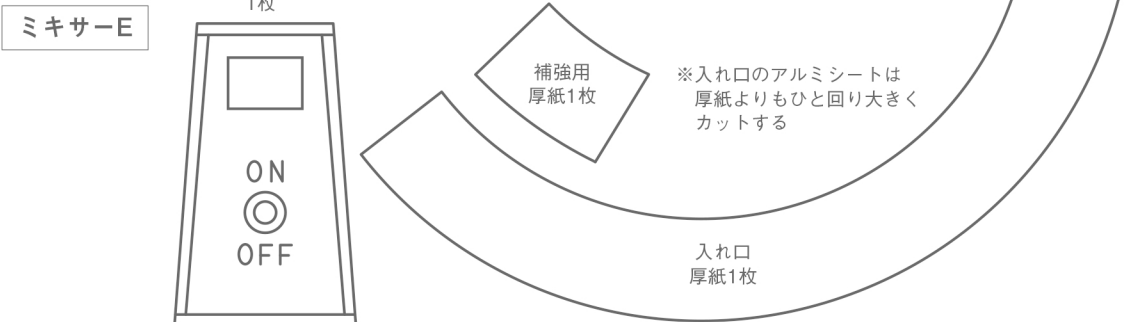

★76 ページ掲載

〈実物大型紙〉

ブレンダー-CD共通

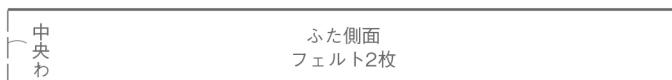
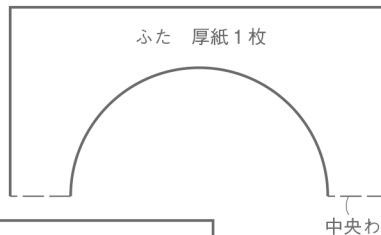
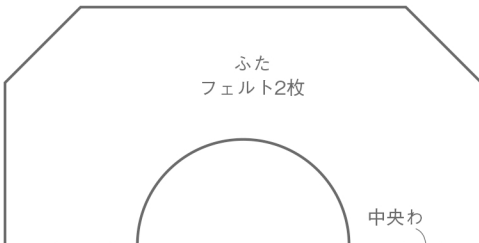
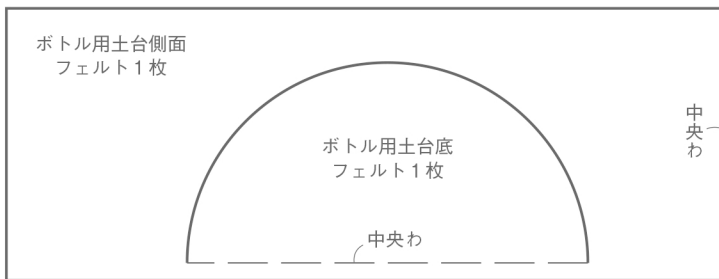
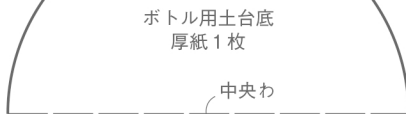
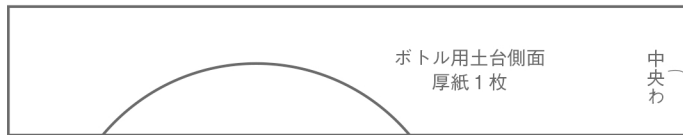
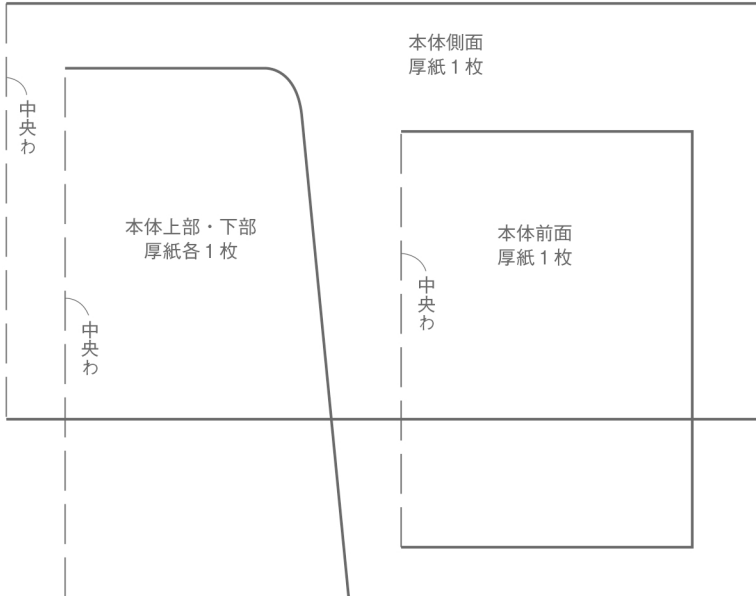

部分ブレンダー-A~F共通

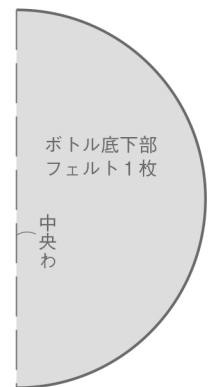
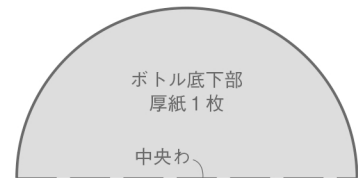
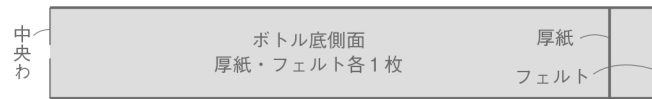
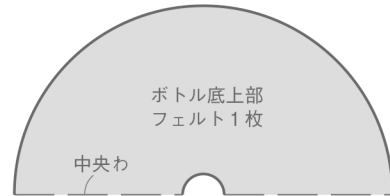
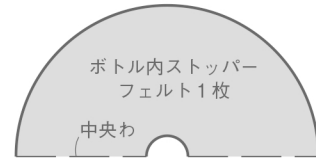
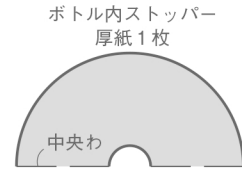

★77 ページ掲載

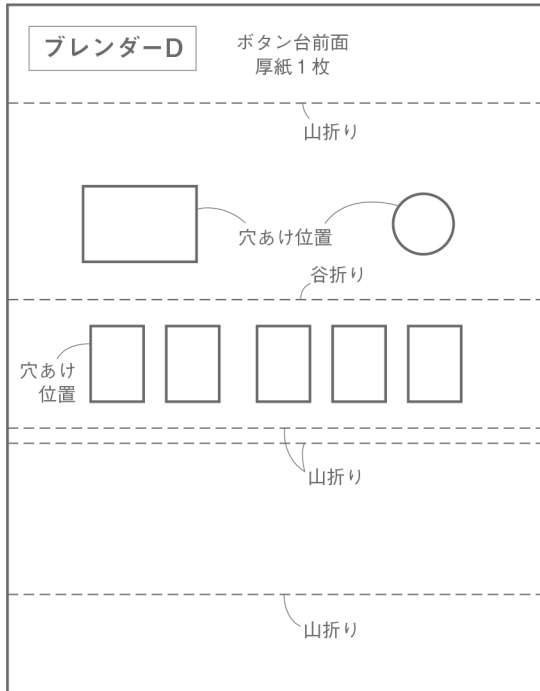

ボタン(1個分)
厚紙1枚
フェルト5枚

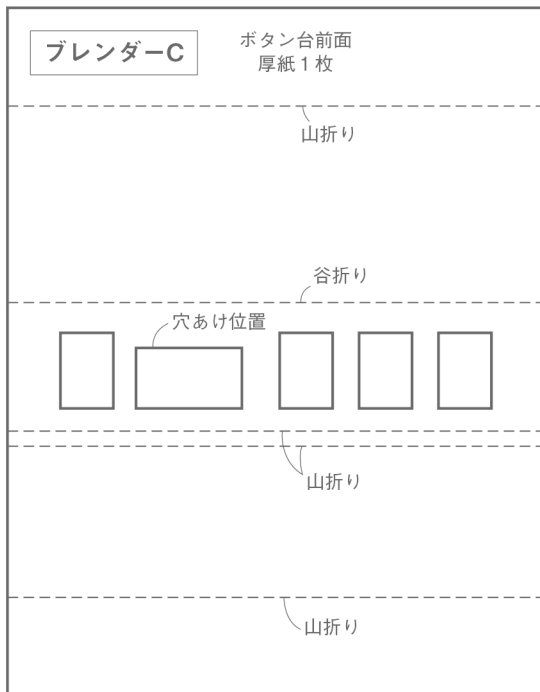
ボタン(1個分)
厚紙1枚
フェルト5枚

ブレンダー-CD共通

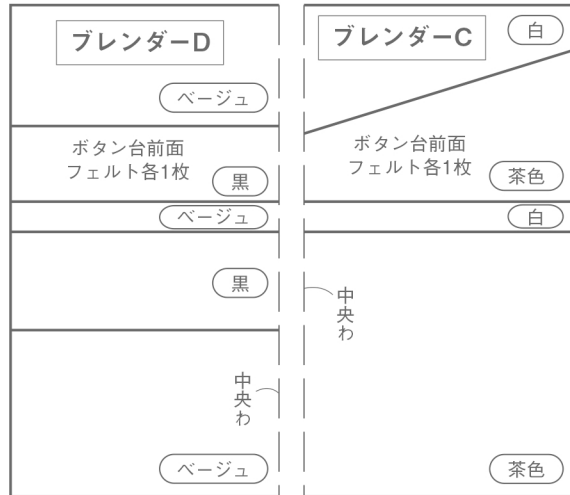
ボタン台

※側面のフェルトは厚紙よりひと回り大きくカットし、厚紙に貼ってから1mm大きくカットする

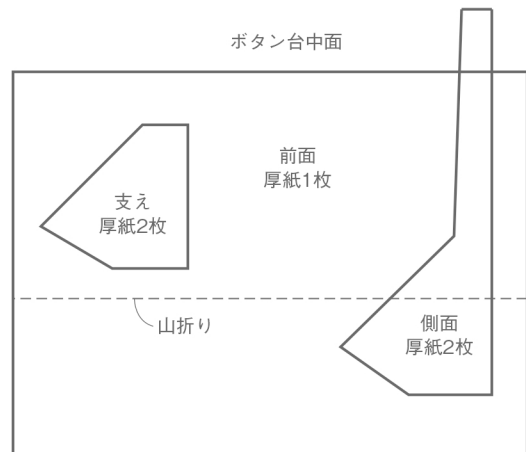
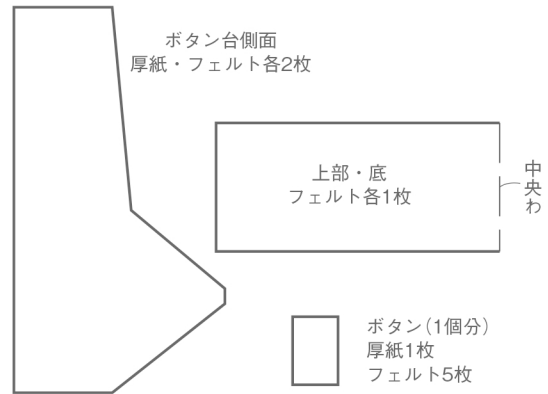

★78 ページ掲載

〈実物大図案〉

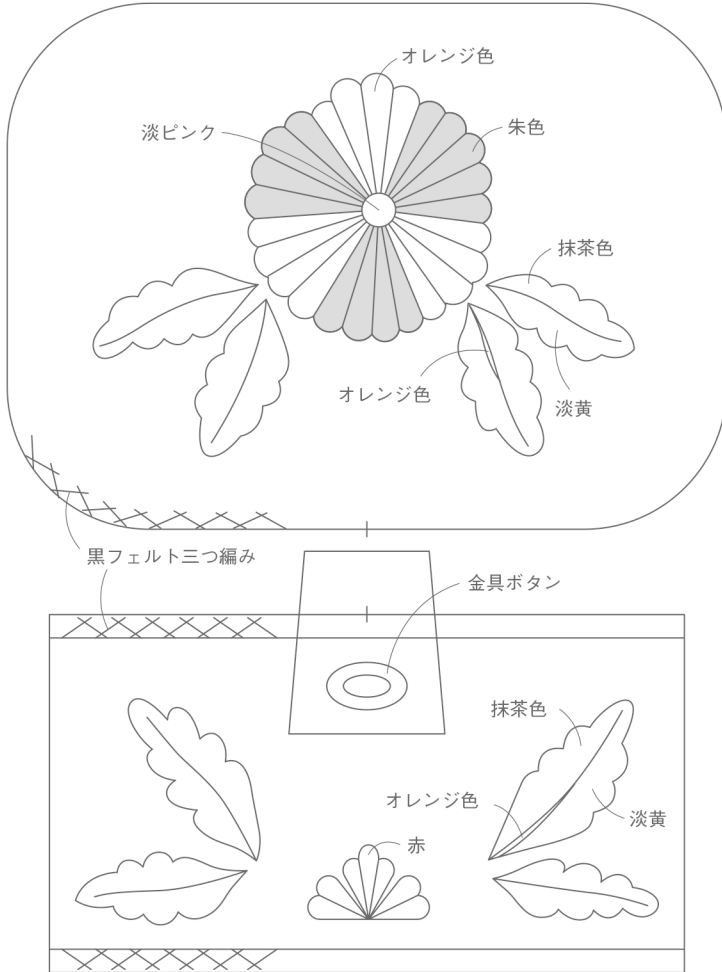

裁縫箱A

持ち手 2本

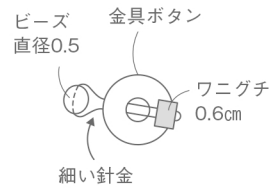
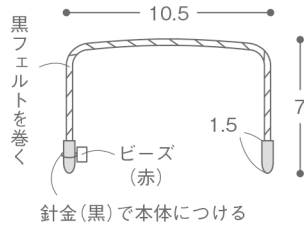

裁縫箱B

本体はヨーグルトの容器
(底縦4.4×横6.2×高さ9.2cm)
高さ4.5cmにカットして使用

持ち手 1本

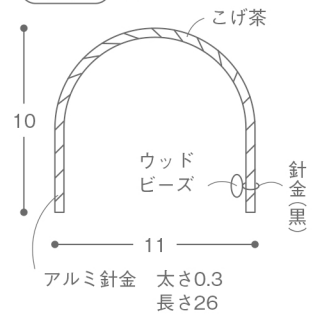

0.3cm径針金に
0.2cm幅のフェルトを巻く

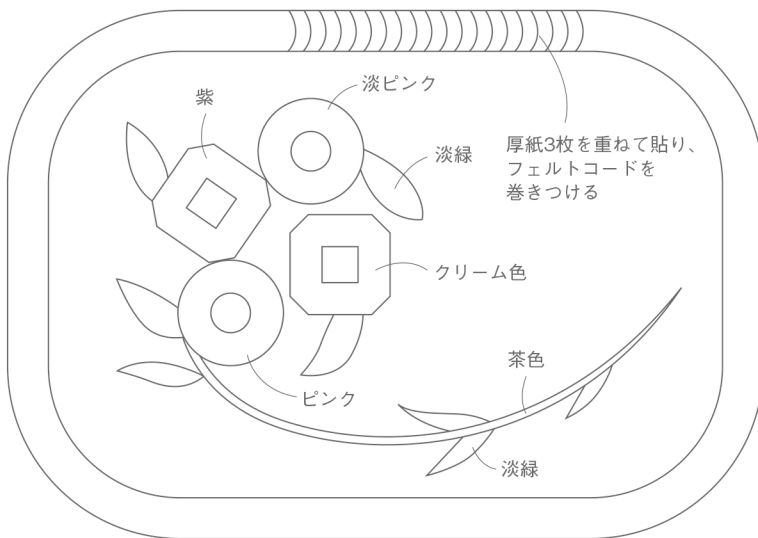

★79 ページ掲載

〈実物大図案〉

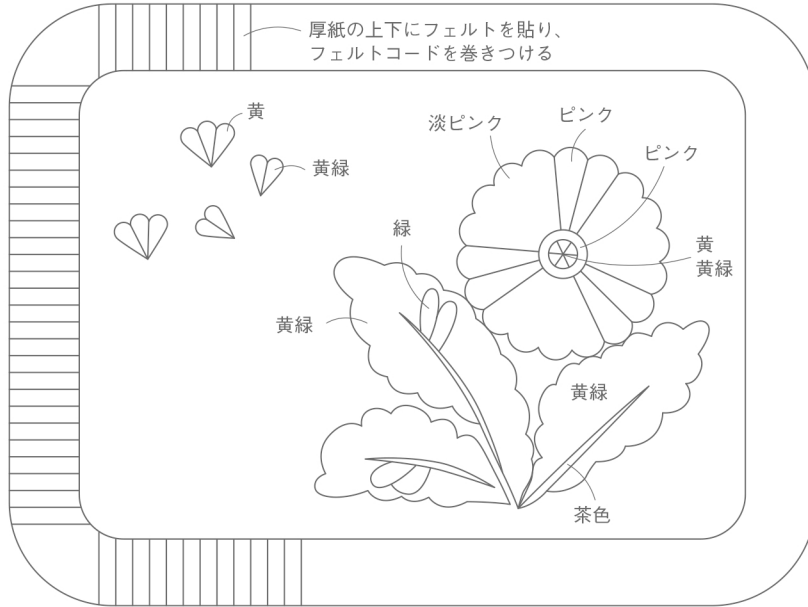

裁縫箱C

本体はみその容器
(底縦6.6×横9.4×高さ7cm)
高さ5cmにカットして使用

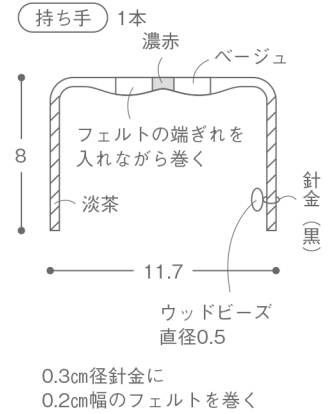

0.3cm径針金に
0.2cm幅のフェルトを巻く

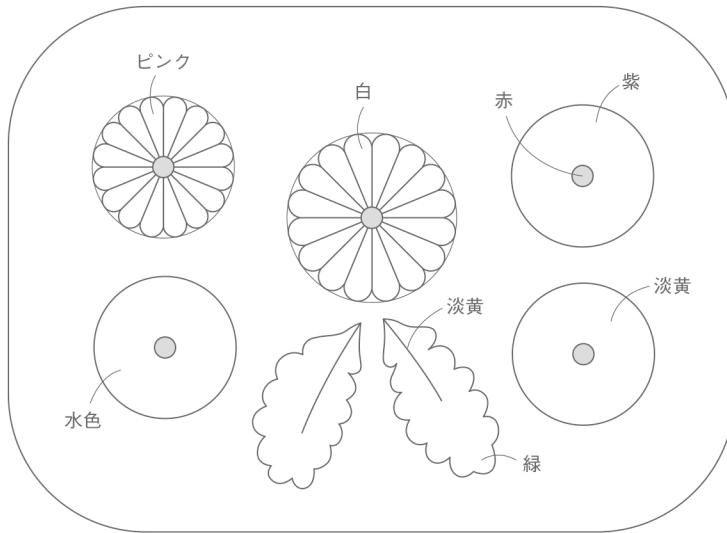

裁縫箱D

本体はAと同じヨーグルトの容器を
高さ4.5cmにカットして使用

